



**SOLICITATION INDEX**

**20. CONTENTS: (DOCUMENTS WITH A YES ARE TO BE SUBMITTED WITH OFFER)**

	NAME	FORM DESCRIPTION	SUBMIT WITH OFFER?
●	Cover Sheet	Solicitation, Offer and Award Form (Complete in its entirety to include Sign and Date)	YES
●	Instructions to Bidders	General Terms & Conditions	YES
		Bid Bond of 5% of Total Amount of Bid	YES
		Delivery Terms	YES
		Payment & Performance Bonds	NO
		Milestone Schedule	NO
	Insurance Certificate		YES
●	Schedule of Subcontractor(s)/Subconsultant(s)	Attachment #1	YES
●	Non-Collusive Bidding Certificate	Vendor Acknowledgement Form	YES
●	Pricing Schedule	Signed and Completed	YES
●	Addenda Checklist	Confirmation Receipt of Addendum(s)	YES
●	Bidder's General Questionnaire	General Questions (Supporting Documentations)	YES
●	CIQ Questionnaire	Conflict of Interest Questionnaire (Signed and Executed)	YES
●	Specifications/Scope of Work	Description of Teller Drive-thru Unit Replacement (4 Exterior/Interior)	YES

<b>21. ACKNOWLEDGMENT OF ADDENDUMS:</b>		ADDENDUMS #	DATE	ADDENDUMS #	DATE
Offeror acknowledges receipt of the following addendum(s) to the solicitation:					
(Identify addendum number and date of each.)					

**\*\*\*Firm name and authorized signature must appear on each page that calls For this information. Failure to do so may disqualify your Bid \*\*\***

**City of Mission**  
**Instructions to Bidder – General Terms & Conditions**  
**Teller Drive-thru Unit Replacements/RFB: 17-146-03-31**

Please read your specifications thoroughly and be sure that the offered complies with all requirements. Any variation from the specifications will not be allowed. If you are the successful bidder, it will be required that **“Teller Drive-thru Unit Replacements”** be provided as specified.

- (1) Sealed bids will be received for **“Teller Drive-thru Unit Replacements”** in accordance with the specifications attached hereto.
- (2) All specifications shown are minimum requirements. There is no intention to disqualify any bidder who can exceed these specifications.
- (3) **One (1) original and two (2) copies of RFB must be enclosed in a sealed envelope with vendor’s name and return address clearly typed/printed on upper left hand corner and proper notation clearly type/printed on the lower left hand corner “Request for Bids” –“Teller Drive-thru Unit Replacements” and delivered to City of Mission Purchasing Department, 1201 East 8<sup>th</sup> Street, Mission, Texas 78572 on or before 2:00 p.m., Friday, March 31, 2017. No Facimiles or late arrivals will be accepted. Any RFB received after that time will not be opened and will be returned. Overnight mail must also be properly labeled on the outside of express envelope or package in reference to RFB.**

(4) Interest of Public Officials

The offeror represents and warrants that no employee, official, or member of the Council (Executive Committee) of the City is or will be peculiarly interested in or benefited directly or indirectly as a result of this contract.

(5) Covenant Against Gratuities

The offeror represents as part of its offer that neither it nor any of its employees, representatives or agents have offered or given gratuities (in the form of entertainment, gifts or otherwise) to any director, officer or employee of the City with the view toward securing favorable treatment in the awarding, amending, or the making of any determination with respect to the performing of the contract.

(6) Preparation of Bids

(a) Bidders are expected to examine the Pricing Schedule, General Terms & Conditions, all drawings, specifications, the statement of work, and all other provisions of, and attachments to, the solicitation, whether incorporated by reference or otherwise, prior to the submission of bids. Failure to do so will be at the bidder's risk.

(b) Each bidder shall furnish the information required by the solicitation. Bids shall be submitted on the bid form contained in the solicitation. Bidders shall sign and print or type their name on the bid form and each continuation sheet on which they make an entry. Erasures or other changes must be initialed by the person signing the bid. Bids signed by an agent of the bidder (other than an officer or a partner of the bidder) are to be accompanied by evidence of the agent's authority (unless such evidence has been previously furnished to the City).

(c) All blanks on the bid form shall be filled in by typewriter or printed in ink with a firm fixed unit price for items bid. Unit prices shall include packing unless otherwise specified. In case of any discrepancy between a unit price and any extended or total price required by the bid form, the unit price will be presumed to be correct, subject, however, to correction to the same extent and in the same manner as any other mistake.

(d) Bids for property or services other than those specified in the Schedule will not be considered unless specifically authorized in the solicitation. Any condition, qualification, or limitation of the bid may be a basis for rejection of the bid as nonresponsive.

(e)The bidder must state a definite time for delivery of property or for performance of services unless otherwise specified in the solicitation. All measurements shall be in the system of weights and measures in common usage in the United States, and pricing shall be in U.S. dollars.

(7) Submission of Bids

(a) Bids and modifications thereof shall be enclosed in sealed envelopes or sealed cartons and submitted to the Buyer of the City of Mission at the address specified in the solicitation. The bidder shall show the hour and date specified in the solicitation for receipt of bids, the solicitation number, and the bidder's name, address, and telephone number on the face of the envelope or carton.

(b) Telegraphic bids will not be considered unless authorized by the solicitation; however, bids may be modified or withdrawn by written or telegraphic notice, provided such notice is received prior to the hour and date specified for receipt of bids.

(c) Samples of items, when required, must be submitted within the time specified and, unless otherwise specified in the solicitation, at no expense to the City. If not destroyed by testing, samples will be returned at the bidder's request and expense, unless otherwise specified in the solicitation.

(d) Each copy of the bid shall include the legal name of the bidder and a statement whether the bidder is a sole proprietorship, a corporation, or any other legal entity. A bid for a corporation shall further give the state of incorporation and have the corporate seal affixed to it.

(8) Explanation to Bidders

Any explanation desired by a bidder regarding the meaning or interpretation of the solicitation, drawings, specifications, etc., must be requested in writing from the City's authorized representative and with sufficient time allowed for a reply to reach bidders before the submission of bids. **Any communication held with city employees, council members, or representatives other than the purchasing staff may be subject to rejection of bid.** Oral explanations or instructions given before the award of any contract, at any pre-bid conferences or otherwise, will not be binding on the City. Information given to a bidder concerning an interpretation of the solicitation may be furnished to all bidders as an addendum to the solicitation, if such information is necessary to bidders in submitting bids on the solicitation or if the lack of such information would be prejudicial to uninformed bidders.

(9) Acknowledgment of Addendums to Invitation for Bids

(a) If this solicitation is amended, then all terms and conditions which are not modified remain unchanged.

(b) Bidders shall acknowledge receipt of any addendums to this solicitation: (1) by signing and returning the addendums; or (2) by identifying the addendums number and date in the space provided for this purpose on the bid form; or (3) by letter or telegram. The City must receive the acknowledgment by the time and at the place specified for receipt of bids.

(10) Bids must give full firm name and address of bidder, and be manually signed. Failure to do so will disqualify your Bid. Person signing bid must show title or **AUTHORITY TO BIND HIS FIRM IN A CONTRACT.** Firm name and authorized signature must appear on each page that calls for this information.

(11) Bids **cannot** be altered or amended after opening time. No Bid may be withdrawn after opening time without acceptable reason in writing and only after approval by the City of Mission.

(12) **STATE SALES TAX MUST NOT BE INCLUDED IN BID.**

(13) No substitutions or cancellations permitted without written approval of the City of Mission.

(14) Any additions, deletions, or variations from the following specifications will not be allowed. Any parts not specifically mentioned which are necessary for the work to be complete and for use or which are normally furnished as standard equipment shall be furnished by the successful Bidder and shall confirm in strength, quality, and workmanship to the accepted standard of the industry.

(15) Number of days required for completion of **“Teller Drive-thru Unit Replacements”** after receiving purchase order must be stated in bid. Failure to so state will obligate bidder to complete the project within **ten (10) business days**.

**a) Completion/Acceptance of Teller Drive-thru Unit Replacements should not exceed (10) business days. Exceeding the number of days shall result in rejection of bid.**

Days to complete work as per specifications after receipt of notice to proceed: \_\_\_\_\_ business days

(16) LIQUIDATED DAMAGES FOR DELAY: And the CONTRACTOR agrees that time is the essence of this contract, and that for each day of delay beyond the number of working days herein agreed upon for the completion of the work herein specified and contracted for (after due allowance for such extension of time as is provided for under Extension of Time herein) above the OWNER may withhold permanently for the CONTRACTOR’S total compensation, the sum of two hundred fifty dollars per day Dollars \$250.00/day as stipulated damages for such delay.

(17) Construction Schedule

(a) Promptly after contract award within seven (7) calendar days, the Contractor shall meet with the City Engineer and Purchasing Staff to discuss project scheduling and, at that meeting, shall submit a practicable schedule showing the order in which the Contractor proposes to perform the work and the dates on which the Contractor contemplates starting and completing the several salient features of the work (including acquiring materials, plant, and equipment). The schedule shall be in the form of a network analysis of suitable scale to indicate appropriately the percentage of the Contractor’s work breakdown schedule which will be completed by any given date during the period. If the Contractor fails to submit a schedule within the time prescribed, Purchasing can proceed with termination and collection on bonds.

(b) The Contractor shall enter the actual progress on the schedule as directed by the City Engineer and, upon doing so, immediately shall deliver a copy of the annotated schedule to the City Engineer. If, in the opinion of the City Engineer, the Contractor falls behind the approved schedule, the Contractor shall take steps necessary to improve its progress, including those that may be required by the City Engineer, without additional cost to the City. In this circumstance, the City Engineer may require the Contractor to increase the number of shifts, overtime operations, days of work, and/or the amount of construction plant, and to submit for approval any supplementary schedule or schedules in chart form as the City Engineer deems necessary to demonstrate how the approved rate of progress will be regained.

(c) Failure of the Contractor to comply with the requirements of the City Engineer under this clause shall be grounds for a determination by the City Engineer that the Contractor is not prosecuting the work with sufficient diligence to ensure completion within the time specified in the contract. Upon making this determination, the City Engineer and Purchasing Director may terminate the Contractor’s right to proceed with the work, or any separable part of it, in accordance with the terms of this contract.

(18) When delay can be foreseen, bidder shall give prior notice to the City of Mission. Bidder must keep City of Mission advised at all times of status of order. Default in promised delivery (without acceptable reasons) or failure to meet specifications, authorizes the City of Mission to purchase such deliver **“Teller Drive-thru Unit Replacements”** off contract. The contractor will be liable for any increase in cost incurred due to defaulting for **“Teller Drive-thru Unit Replacements”**.

a. Acceptable reasons for delayed delivery(ies) are as follows; Act of God (floods, tornadoes, hurricanes, etc.), acts of government, fire strikes, war or any actions beyond the control of the successful Bidder.

(19) Default

(a) If the Contractor refuses or fails (i) to commence the work within the time required by this contract, (ii) to prosecute the work or any separable part with the diligence that will ensure its completion within the time specified in this contract, including any extension, (iii) to provide sufficient and properly skilled workmen or proper materials or equipment to complete the work in an acceptable manner and without delay, (iv) to promptly pay its subcontractors, laborers, and materialmen, (v) to perform any of its other obligations under this contract, or (vi) to complete the work within the time specified in this contract ("events of default"), the City may, by written notice to the Contractor, terminate the right to proceed with the work (or the separable part of the work). In this event, the City may take over the work and complete it by contract or otherwise, and may take possession of and use any materials, appliances, and plant on the work site necessary for completing the work. The Contractor and its sureties shall be liable for any damage to the City resulting from events of default, whether or not the Contractor's right to proceed with the work is terminated. This liability includes any increased costs incurred by the City in completing the work.

(b) The Contractor's right to proceed shall not be terminated because of delays nor the Contractor charged with damages under this clause, if --

(1) the delay in completing the work arises from unforeseeable causes beyond the control and without the fault or negligence of the Contractor (examples of such causes include (i) acts of God or of the public enemy, (ii) acts of the City in either its public or contractual capacity, (iii) acts of another Contractor in the performance of a contract with the City, (iv) fires, (v) floods, (vi) epidemics, (vii) quarantine restrictions, (viii) strikes, (ix) freight embargoes, (x) unusually severe weather, or (xi) delays of subcontractors or suppliers at any tier arising from unforeseeable causes beyond the control and without the fault or negligence of both the Contractor and the subcontractors or suppliers); and

(2) the Contractor, within 10 days from the beginning of any delay (unless extended by the City Engineer), notifies the City Engineer and Purchasing Staff in writing of the causes of delay. The City Engineer shall ascertain the facts and the extent of the delay. If, in the judgment of the City Engineer, the findings of fact warrant such action, the time for completing the work shall be extended.

(c) The rights and remedies of the City in this clause are in addition to any other rights and remedies provided by law or under this contract. Time is of the essence for all delivery, performance, submittal, and completion dates in this contract.

(20) Evaluation and Basis for Award

(A) One Award

One contract award will be made under this Request for Bids. Multiple contract awards shall not be made.

(B) Definite Quantities

The quantities specified in the Schedule shall be purchased under this solicitation.

(C) Unit and Extended Pricing

Offerors shall insert the unit price and extended amount for each line item offered on the price schedule. If a line item is offered at "No Cost," enter "No Cost" in the unit price column. Additionally, offerors shall calculate and insert the total price in the space provided on the price schedule.

(21) Award of Contract

(A) The contract will be awarded to the lowest responsive and responsible bidder whose bid, conforming to the solicitation, will be most advantageous to the City, price and other factors considered. A responsible bidder is one who affirmatively demonstrates to the City that the bidder has adequate financial resources and the requisite capacity, capability, and facilities to perform the contract within the delivery period or period of performance, has a satisfactory record of performance on other comparable projects, has a satisfactory record of integrity and business ethics, and is otherwise qualified and eligible to receive award under the solicitation and laws or regulations applicable to the procurement.

- (B) The acceptability evaluation is not conducted for the purpose of determining whether one bidder's item is superior to another but only to determine that a bidder's offering is acceptable as set forth in the Request for Bids. Any bidder's offering which does not meet the acceptability requirements shall be rejected as non-responsive.
- (C) A written award (or acceptance of bid) which is mailed, telegraphed, or otherwise furnished to the successful bidder within the time for acceptance specified in the solicitation shall be deemed to result in a binding contract without further action by either party.
- (D) Any financial data submitted with any bid hereunder or any representation concerning facilities or financing will not form a part of any resulting contract; provided, however, that if the resulting contract contains a clause providing for price reduction for defective cost or pricing data, the contract price will be subject to reduction if cost or pricing data furnished hereunder is incomplete, inaccurate, or not current.
- (22) The City of Mission reserves the right to reject any or all bids, to waive any or all formalities or technicalities, and to make such awards of contract as may be deemed to be the best and most advantageous to the City of Mission.
- (23) Unless otherwise specified, any catalog or manufacturer's reference or brand name used in describing an item is merely descriptive, and not restrictive, and is used only to indicate type, style or quality of material desired. If a bidder quotes on an article other than the one specified, which he/she considers comparable, the name and grade of said article must be specified in the bid and sufficient specifications and descriptive data must accompany same to permit thorough evaluation. In the absence of these qualifications, he/she will be expected to furnish the article called for.
- (24) The Bidder agrees to indemnify and save harmless the City, the Purchasing Agent and any assistants from all suits and actions of every nature and descriptive brought against them or any of them, for or on account of the use of patented appliances, products or processes, and he/she shall pay all royalties and charges which are legal and equitable. Evidence of such payment or satisfaction shall be submitted upon request of the Purchasing Agent, as a necessary requirement in connection with the final estimate for payment in which such patented appliance, products or processes are used.
- (25) Bidder shall carefully examine the bid forms, specifications, and instructions to Bidder. Should the Bidder find discrepancies in, or omissions from Bid forms, specifications, or other documents, or should he/she be in doubt as to their meaning, he/she should at once notify the Purchasing Agent (Mission City Hall, (956) 580-8667) and obtain clarification by addendum prior to submitting any Bid.
- a. BILLING AND PAYMENT INSTRUCTIONS:
  - b. Invoices must include:
  - c. Name and address of successful vendor
  - d. Name and address of receiving department or official
  - e. Purchase Order Number (if any)
  - f. Notation - **“Teller Drive-thru Unit Replacements”**
  - g. Descriptive information as to the items or services delivered, including product code, item number, quantity etc.

The City of Mission will execute payment by mail within thirty (30) working days after each percentage of work has been completed and found to meet specifications for **“Teller Drive-thru Unit Replacements”** as indicated below. No other method of payment will be considered. Payment will be authorized in the following manner:

Payment #1:	45% of price at 50% completion
Payment #2:	45% of price at 100% completion
Payment #3: (10% Retainage)	31 days after completion of project

- (26) Funds for this procurement have been provided through the City budget for this fiscal year only. City, on an annual basis, has the right to reconsider a contract during the budget process for the ensuing years if financial

resources of City are insufficient to meet the liabilities of said contract. The award of a bid or contract hereunder will not be construed to create a debt of the City which is payable out of funds beyond the current fiscal year.

(27) The bidder is specifically advised that the bid must be accompanied by a bid bond from a reliable surety company licensed to operate in the State of Texas, totaling five percent (5%) of the total amount of the bid for the project, as a guaranty that if awarded the bid, the bidder shall meet all specification requirements and delivery date(s). A certified cashier's check will be allowed in lieu of a bid bond for five (5%) of the total amount for the project.

- a) Bidder's failure to comply with specification requirements, terms and conditions, bonds and delivery date(s) shall forfeit the check(s) or bid bond(s) as identified in this paragraph of these general terms and conditions to bidders. Such check(s) or bid bond(s) will be returned to all except three lowest bidders within ten(10) business days after opening of bids, and the remaining check(s) or bid bond(s) to exclude the successful bidders will be returned promptly after an official awarded of contract.
- b) Certified cashier's check or bid bond from a reliable surety company of the awarded bidder shall be returned upon receipt of final delivery/acceptance of said goods or services along with payment/performance bond(s) by the Owner. If no award has been made within (60) days after opening of bids, check(s) and/or bid bond(s) will be returned accordingly.

(28) All contracts shall require the contractor, before beginning the work, to execute to the City a payment of bond of the contract amount if in excess of \$25,000.00 and a performance bond if the contract is in excess of \$100,000.00.

- a. Performance and Payment bonds are to be submitted to the City of Mission within seven (7) business days from notice of award.

(29) The geographical location(s) of bidder's facilities referenced "**Teller Drive-thru Unit Replacements**" given due consideration in determining the lowest responsible bidder. All items will be evaluated and awarded individually or in any combination thereof.

(30) Bidders are advised that any part of the specifications that are not met within the time of delivery regardless of how major or minor it might be or shall be grounds for none acceptance of delivery and forfeiture of bid bond.

(31) The City of Mission reserves the right to waive or take exception to any part of the specifications when in the best interest of the City of Mission.

(32) Number of days and/or weeks stated on bid form for completion of supply/service will be a factor in the evaluation and award to bid.

(33) Accident Prevention

(a) In performing this contract, the Contractor shall provide for protecting the lives and health of employees and other persons; preventing damage to property, materials, supplies, and equipment; and avoiding work interruptions. For these purposes, the Contractor shall: (1) provide appropriate safety barricades, signs, and signal lights; (2) comply with all safety standards required by federal, state, or local law and any additional standards customarily employed in connection with the type of work being performed or the conditions at the site; and (3) ensure that any additional measures the City Engineer determines to be reasonably necessary for this purpose are taken.

(b) The Contractor shall maintain an accurate record of exposure data on all accidents incident to work performed under this contract resulting in death, traumatic injury, occupational disease, or damage to property, materials, supplies, or equipment. The Contractor shall report this data in the manner prescribed by the Purchasing Staff.

(c) The Contracting Officer shall notify the Buyer of any noncompliance with these requirements and of the corrective action required. This notice, when delivered to the Contractor or the Contractor's representative at the site of the work, shall be deemed sufficient notice of the noncompliance and corrective action required. After receiving the notice, the Contractor shall immediately take corrective action. If the Contractor fails or refuses to take corrective action promptly, the City Engineer may issue an order stopping all or part of the work until satisfactory



corrective action has been taken. The Contractor shall not base any claim or request for equitable adjustment for additional time or money on any stop order issued under these circumstances.

(d) The Contractor shall be responsible for its subcontractors' compliance with this clause.

(34) Permits and Responsibilities

The Contractor shall, without additional expense to the City, be responsible for obtaining any necessary licenses and permits and for complying with any federal, state, county, and municipal laws, codes, and regulations applicable to the performance of the work, including, but not limited to, any laws or regulations requiring the use of licensed contractors to perform parts of the work. The Contractor also shall be responsible for all damages to persons or property that occur as a result of the Contractor's fault or negligence and shall take proper safety and health precautions to protect the work, the workers, the public, and the property of others. The Contractor also shall be responsible for all materials delivered and work performed until completion and acceptance of the entire work, except for any completed unit of work which may have been accepted under the contract.

(35) Insurance Requirements for Supply/Services and/or Construction

(a) Required Coverage. The Contractor shall, at all times during the term of this contract and extended terms thereof, provide and maintain the following types of insurance protecting the interests of the City of Mission and the Contractor with limits of liability not less than those specified below.

Commercial General Liability insurance or its equivalent, **listing City of Mission as an additional insured**, providing limits of not less than \$500,000 for bodily injury and property damage per occurrence, consistent with potential exposure to City under the Texas Tort Claims Act. Coverage should include injury to or death of persons and property damage claims arising out of the services, construction, etc. provided with a general aggregate of \$1,000,000, and a products and completed operations aggregate of \$1,000,000. Coverage should include: Damaged to rented premises at a minimum of \$100,000 per occurrence. There shall not be any policy exclusions or limitations for the following as well:

- Contractual Liability covering Contractor's obligations herein
- Personal Injury Advertising Liability
- Medical Payments
- Fire Damage Legal Liability
- Broad Form Property Damage
- Liability for Independent Contractors

(b) Automobile liability insurance policy with combined single limit of at least Five Hundred Thousand Dollars (\$500,000.00) per occurrence, consistent with potential exposure to City under the Texas Tort Claims Act.

(c) Uninsured/Underinsured motorist coverage in an amount equal to the bodily injury limits set forth immediately above;

(d) A Five Hundred Thousand Dollar (\$500,000.00) Comprehensive General Liability insurance policy providing additional coverage to all underlying liabilities of City consistent with potential exposure of City under the Texas Tort Claims Act;

(e) Workers' Compensation and Employers' Liability- insurance is equivalent to State of Texas Workers' Compensation Statutory Limits, providing limits of not less than \$1,000,000 for each accident, each disease per employee \$1,000,000, and policy limit of no less than \$1,000,000. There shall not be any policy exclusions or limitations.

(f) Certificates of Insurance. Before commencing execution of this contract, and within 7 calendar days from date of award of contract, the Contractor shall furnish Original proof of insurance via Certificates of Insurance satisfactory to the City of Mission at the following addresses,

City of Mission  
Crissy Cantu, Buyer  
1201 E. 8<sup>th</sup> Street  
Mission, TX 78572  
Bid # 17-146-03-31

evidencing that insurance as required by paragraph (a) above is in force, stating policy number dates of expiration and limits of liability thereunder. All copies of policies and Certificates of Insurance submitted to the City shall be in a form and content acceptable to the City.

(g) Approval of Forms and Companies. All coverage described in this contract shall be in a form and content satisfactory to the Purchasing Agent. No party subject to the provisions of this contract shall violate or knowingly permit to be violated any of the provisions of the policies of insurance described herein. All insurance should be provided by insurance companies with a Best's rating of A- or better. Please include proof of such rating with your coverage documents.

(h) Additional Insured Endorsement. The policy or policies providing Commercial General Liability, and as otherwise required above, shall be endorsed to name City of Mission, their directors, officers, representatives, agents, and employees as Additional Insurers with respects to operations performed by or on behalf of the Contractor in the performance of this contract via ISO endorsements CG 2037 or its equivalent. The policy shall also be endorsed to name other interests as directed by City of Mission.

(i) Notice of Cancellation or Material Changes. Policies and/or Certificates shall **specifically** provide that a thirty (30) day notice of cancellation, non-renewal, or material change be sent to the City.

(j) Multiple Policies. The limits of liability as required above may be provided by a single policy of insurance or a combination of primary, excess, or umbrella liability policies. But in no event shall the total limit of liability of any one occurrence or accident be less than the amount shown above.

(k) Deductibles. Companies issuing the insurance policies and the Contractor shall have no recourse against the City for payment of any premiums or assessments for any deductibles, as all such premiums and deductibles are the sole responsibility and risk of the Contractor.

(l) Subcontractors. If any part of the work is sublet, the Contractor shall require any and all subcontractors performing work under this contract to carry General Liability and Products, and Construction Liability Insurance, with limits of liability that Contractor shall deem appropriate and adequate to protect the interests of the City. In the event a subcontractor is unable to furnish insurance in accordance to section (a) above, the Contractor shall endorse the subcontractor as an Additional Insured. Insurance certificates for subcontractors shall be furnished to the City of Mission upon request.

(m) No Release. The carrying of the above-described coverage shall in no way be interpreted as relieving the Contractor of any other responsibility or liability under this agreement, or any applicable law, statute, regulation, or order.

(36) Bidders are advised that they must be in compliance with the below mentioned law:

**CHAPTER 176 OF THE TEXAS LOCAL GOVERNMENT CODE**

Effective January 1, 2006, Chapter 176 of the Texas Local Government Code requires that any vendor or person considering doing business with a local government entity disclose in the Questionnaire Form CIQ, the vendor or person's affiliation or business relationship that might cause a conflict of interest with a local government entity. By law, this questionnaire must be filed with the records administrator of the City of Mission not later than the 7th business day after the date the person becomes aware of facts that require the statement be filed. See Section 176.006, Local Government Code. A person commits an offense if the person violates Section 176.006, Local Government Code. An offense under this section is a Class C misdemeanor.

For more information or to obtain Questionnaire CIQ go to the Texas Ethics Commission web page at [www.ethics.state.tx.us/forms/CIQ.pdf](http://www.ethics.state.tx.us/forms/CIQ.pdf).

**IF YOU HAVE ANY QUESTIONS ABOUT COMPLIANCE, PLEASE CONSULT YOUR OWN LEGAL COUNSEL. COMPLIANCE IS THE INDIVIDUAL RESPONSIBILITY OF EACH PERSON OR AGENT OF A PERSON WHO IS SUBJECT TO THE FILING REQUIREMENT. AN OFFENSE UNDER CHAPTER 176 IS A CLASS “C” MISDEMEANOR.**

(37) Disclosure of Interested Parties

Contractor is to comply with Government Code Section 2252.908 enacted by H.B. 1295, which prohibits a government entity or state agency from entering into certain contracts with a business entity unless the business entity submits a disclosure of interested parties. For more information go to the Texas Ethics Commission web page at: [https://www.ethics.state.tx.us/whatsnew/elf\\_info\\_form1295.htm](https://www.ethics.state.tx.us/whatsnew/elf_info_form1295.htm)

(38) Milestone Schedule

The Contractor must submit a brief schedule within 7 calendar days from Notice of Award showing how he intends to organize and perform the work for this contract.

(39) Termination of Contract: The City of Mission reserves the right to terminate the contract if, in the opinion of the City of Mission, the successful vendor's performance is not acceptable, if the City is being repeatedly overcharged, improperly charged, no funds available, or if the City wishes, without cause, to discontinue this contract. Termination will be in written form allowing a 30-day notice.



CITY OF MISSION  
**PRICING SCHEDULE**

BID NAME/NO.: **“Teller Drive-thru Unit Replacements” Bid #: 17-146-03-31**

No.	Qty	UOM	Item Description	Lump Sum
1.	4	Sets	Teller Drive-thru Unit Replacements (Exterior / Interior)	\$ _____

For any questions directly regarding the **“Teller Drive-thru Unit Replacements”**, please call Crissy Cantu, Buyer (956) 580-8667.

**Company Name:** \_\_\_\_\_  
**Owner or President Name:** \_\_\_\_\_  
**Company Address:** \_\_\_\_\_  
**City, State, Zip Code:** \_\_\_\_\_  
**Telephone Number:** \_\_\_\_\_  
**Fax Number:** \_\_\_\_\_  
**Email:** \_\_\_\_\_  
**Tax ID Number:** \_\_\_\_\_

\_\_\_\_\_  
**\*Company Representative’s Signature**

\_\_\_\_\_  
**Date**

\_\_\_\_\_  
**Company Representative’s Name (Please Print)**

\_\_\_\_\_  
**Company Representative’s Title**

**\*Signature on this form indicates agreement with “Instructions to Bidder-General Terms and Conditions and Pricing Schedule”**

**CITY OF MISSION**  
**VENDOR ACKNOWLEDGMENT FORM - NON-COLLUSIVE BIDDING CERTIFICATION**  
**Bid Name/No.: "Teller Drive-thru Unit Replacements" / 17-146-03-31**

I/We have read instructions to bidder and specifications. My/Our bid conforms to all bid specifications, conditions, and instructions as outlined by *CITY OF MISSION*.

Signing the Acknowledgment Form confirms that our company will enter into a binding contract with CITY OF MISSION for item(s) awarded to our company. I/We have read instructions to bidder and specifications.

The undersigned Bidder, by signing and executing this bid, certifies and represents to the CITY OF MISSION that Bidder has not been offered, conferred or agreed to confer any pecuniary benefit, as defined by §1.07(a)(6) of the Texas Penal Code, or any other thing of value as consideration for the receipt of information or any special treatment or advantage relating to this bid; the Bidder also certifies and represents that Bidder has not offered, conferred or agreed to confer any pecuniary benefit or other things of value as consideration for the recipient's decision, opinion, recommendation, vote or other exercise of discretion concerning this bid; the Bidder certifies and represents that Bidder has neither coerced nor attempted to influence the exercise of discretion by any officer, trustee, agent or employee of the CITY OF MISSION concerning this bid on the basis of any consideration not authorized by law; the Bidder also certifies and represents that Bidder has not received any information not available to other bidders so as to give the undersigned a preferential advantage with respect to this bid; the Bidder further certifies and represents that Bidder has not violated any state, federal or local law, regulation or ordinance relating to bribery, improper influence, collusion or the like and that Bidder will not in the future offer, confer, or agree to confer any pecuniary benefit or other thing of value to any officer, trustee, agent or member of the CITY OF MISSION in return for the person having exercised the person's official discretion, power or duty with respect to this bid; the Bidder certifies and represents that it has not now and will not in the future offer, confer, or agree to confer a pecuniary benefit or other thing of value to any officer, trustee, agent or member of CITY OF MISSION in connection with information regarding this bid, the submission of this bid, the award of this bid or the performance, delivery or sale pursuant to this bid.

Date: \_\_\_\_\_  
Company Name: \_\_\_\_\_  
Signature: \_\_\_\_\_  
Title: \_\_\_\_\_

**Note: This form must be filled in and submitted with the sealed bid.**

**ADDENDA CHECKLIST**

**Bid of:** \_\_\_\_\_  
(Bidder Company Name)

**To:** City of Mission

**Ref.:** Teller Drive-thru Unit Replacements/RFB No.: 17-146-03-31

Ladies and Gentlemen:

The undersigned Bidder hereby acknowledges receipt of the following Addenda to the captioned RFB (initial if applicable).

No. 1 \_\_\_\_\_ No. 2 \_\_\_\_\_ No. 3 \_\_\_\_\_ No. 4 \_\_\_\_\_ No. 5 \_\_\_\_\_

Respectfully submitted,

**Bidder:** \_\_\_\_\_

**By:** \_\_\_\_\_

(Authorized Signature for Bidder)

**Name:** \_\_\_\_\_

**Title:** \_\_\_\_\_

**Date:** \_\_\_\_\_

**GENERAL BUSINESS QUESTIONNAIRE**  
**(SUPPLIES, SERVICES AND CONSTRUCTION)**

This questionnaire, the requested list of references and the authorization to release financial information are used in part to assist in determining a potential contractor's responsibility. Offerors shall submit the General Business Questionnaire information within two (2) work days from the date of notification by the City, or with the offer, if so indicated in the Table of Contents page 2 of the Solicitation, Offer and Award Form. All information must be current and traceable. Each venturer of a joint venture must submit a separate signed form.

City of Mission reserves the right to make additional inquiries based on information submitted, or the lack thereof. Questions concerning this questionnaire or the authorization form should be directed to the contact person identified on the Solicitation, Offer and Award Form. In cases where a question does not apply or if unable to respond, offeror should refer to the item number, repeat the question, and indicate N/A (Not Applicable) or N/R (No Response), as appropriate. Offeror will explain the reason when responding N/A or N/R.

1. Name of Offeror ("Business"): \_\_\_\_\_
  
2. List name(s) and business address of officers and directors for corporations, partners for partnerships, and venturers for joint ventures (attach additional pages as necessary).  
\_\_\_\_\_  
\_\_\_\_\_  
\_\_\_\_\_
  
3. Number of years in business under present business name: \_\_\_\_\_
  
4. If applicable, list all other names under which the Business identified above operated in the last 5 years.  
\_\_\_\_\_  
\_\_\_\_\_  
\_\_\_\_\_
  
5. Annual Gross Revenue (Past year): (M represents millions, K represents thousands)  
\$100K or less    \$100K-\$500K    \$500K-\$1M    \$1M-\$5M    \$5M-\$10M  
\$10M-\$16M    \$16M or Over
  
6. Will bidder/proposer provide a copy of its financial statements for the past two (2) years, if requested by City of Mission? Yes No
  
7. Number of current employees: \_\_\_\_\_
  
8. Has the Business, or any officer or partner thereof, failed to complete a contract? Yes No
  
9. Is any litigation pending against the Business? Yes No
  
10. Is offeror currently for sale or involved in any transaction to expand or to become acquired by another business entity? If yes, offeror needs to explain the expected impact, both in organizational and directional terms. Yes No  
\_\_\_\_\_  
\_\_\_\_\_  
\_\_\_\_\_



11. Has the Business ever been declared "not responsible" for the purpose of any governmental agency contract award? Yes No
12. Has the Business been debarred, suspended, proposed for debarment, declared ineligible, voluntarily excluded, or otherwise disqualified from bidding, proposing, or contracting? Yes No
13. Are there any proceedings pending relating to the Business' responsibility, debarment, suspension, voluntary exclusion, or qualification to receive a public contract? Yes No
14. Has the government or other public entity requested or required enforcement of any of its rights under a surety agreement on the basis of a default or in lieu of declaring the Business in default? Yes No
15. Is the Business in arrears on any contract or debt? Yes No
16. Has the Business been a defaulter, as a principal, surety, or otherwise? Yes No
17. Have liquidated damages or penalty provisions been assessed against the Business for failure to complete work on time or for any other reason? Yes No
18. Does offeror have a contingency plan or disaster recovery plan in the event of a disaster? If so, then Bidder will provide a copy of the plan. Yes No
19. Does offeror have quality assurance program? If yes, offeror will describe its quality assurance program, its quality requirements, and how they are measured. Yes No
20. If a "yes" response is given under questions 9 through 19, please provide a detailed explanation including dates, reference to contract information, contacts, etc. (attach additional pages as necessary).

---



---



---



---



---



---

I, individually and on behalf of the business named in this Business Questionnaire, do by my signature below, certify that the information provided in this questionnaire is true and correct. I understand that any false statements or misrepresentations regarding the Business named above may result in: 1) termination of any or all contracts which City of Mission has or may have with the Business; 2) disqualification of the Business from consideration for contracts; 3) removal of the Business from City of Mission's vendors' list; or/and 4) legal action(s) applicable under federal, state, or local law.

Name: \_\_\_\_\_ Title: \_\_\_\_\_  
 Signature: \_\_\_\_\_ Date: \_\_\_\_\_  
 (Owner, CEO, President, Majority Stockholder or Designated Representative)

## LIST OF REFERENCES FOR SIMILAR PROJECTS

Use additional pages as necessary.

1. Project:  
Date of Completion (if applicable):  
Contact Person:  
Company Name:  
Address:  
Telephone Number:  
Fax Number:  
E-mail Address:

2. Project:  
Date of Completion (if applicable):  
Contact Person:  
Company Name:  
Address:  
Telephone Number:  
Fax Number:  
E-mail Address:

3. Project:  
Date of Completion (if applicable):  
Contact Person:  
Company Name:  
Address:  
Telephone Number:  
Fax Number:  
E-mail Address:

4. Project:  
Date of Completion (if applicable):  
Contact Person:  
Company Name:  
Address:  
Telephone Number:  
Fax Number:  
E-mail Address:

# CONFLICT OF INTEREST QUESTIONNAIRE

# FORM CIQ

For vendor or other person doing business with local governmental entity

This questionnaire reflects changes made to the law by H.B. 1491, 80th Leg., Regular Session.

This questionnaire is being filed in accordance with Chapter 176, Local Government Code by a person who has a business relationship as defined by Section 176.001(1-a) with a local governmental entity and the person meets requirements under Section 176.006(a).

By law this questionnaire must be filed with the records administrator of the local governmental entity not later than the 7th business day after the date the person becomes aware of facts that require the statement to be filed. See Section 176.006, Local Government Code.

A person commits an offense if the person knowingly violates Section 176.006, Local Government Code. An offense under this section is a Class C misdemeanor.

## OFFICE USE ONLY

Date Received

**1** Name of person who has a business relationship with local governmental entity.

**2**  Check this box if you are filing an update to a previously filed questionnaire.

(The law requires that you file an updated completed questionnaire with the appropriate filing authority not later than the 7th business day after the date the originally filed questionnaire becomes incomplete or inaccurate.)

**3** Name of local government officer with whom filer has employment or business relationship.

\_\_\_\_\_  
Name of Officer

This section (item 3 including subparts A, B, C & D) must be completed for each officer with whom the filer has an employment or other business relationship as defined by Section 176.001(1-a), Local Government Code. Attach additional pages to this Form CIQ as necessary.

A. Is the local government officer named in this section receiving or likely to receive taxable income, other than investment income, from the filer of the questionnaire?

Yes       No

B. Is the filer of the questionnaire receiving or likely to receive taxable income, other than investment income, from or at the direction of the local government officer named in this section AND the taxable income is not received from the local governmental entity?

Yes       No

C. Is the filer of this questionnaire employed by a corporation or other business entity with respect to which the local government officer serves as an officer or director, or holds an ownership of 10 percent or more?

Yes       No

D. Describe each employment or business relationship with the local government officer named in this section.

**4**

\_\_\_\_\_  
Signature of person doing business with the governmental entity

\_\_\_\_\_  
Date

**CITY OF MISSION  
SPECIFICATIONS**

**BID NAME/NO.:**

**Teller Drive-thru Unit Replacements  
(4 exterior/interior) /  
17-146-03-31**

**“See Attached Plans & Specifications”**

2 of 120VAC 20 AMP DEDICATED CIRCUIT  
TO WATERPROOF DUPLEX OUTLETS FOR EA.  
TERMINAL BLOWERS

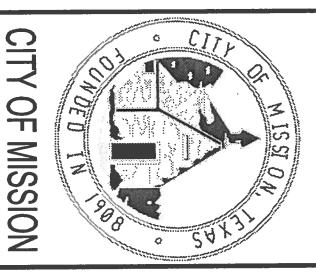
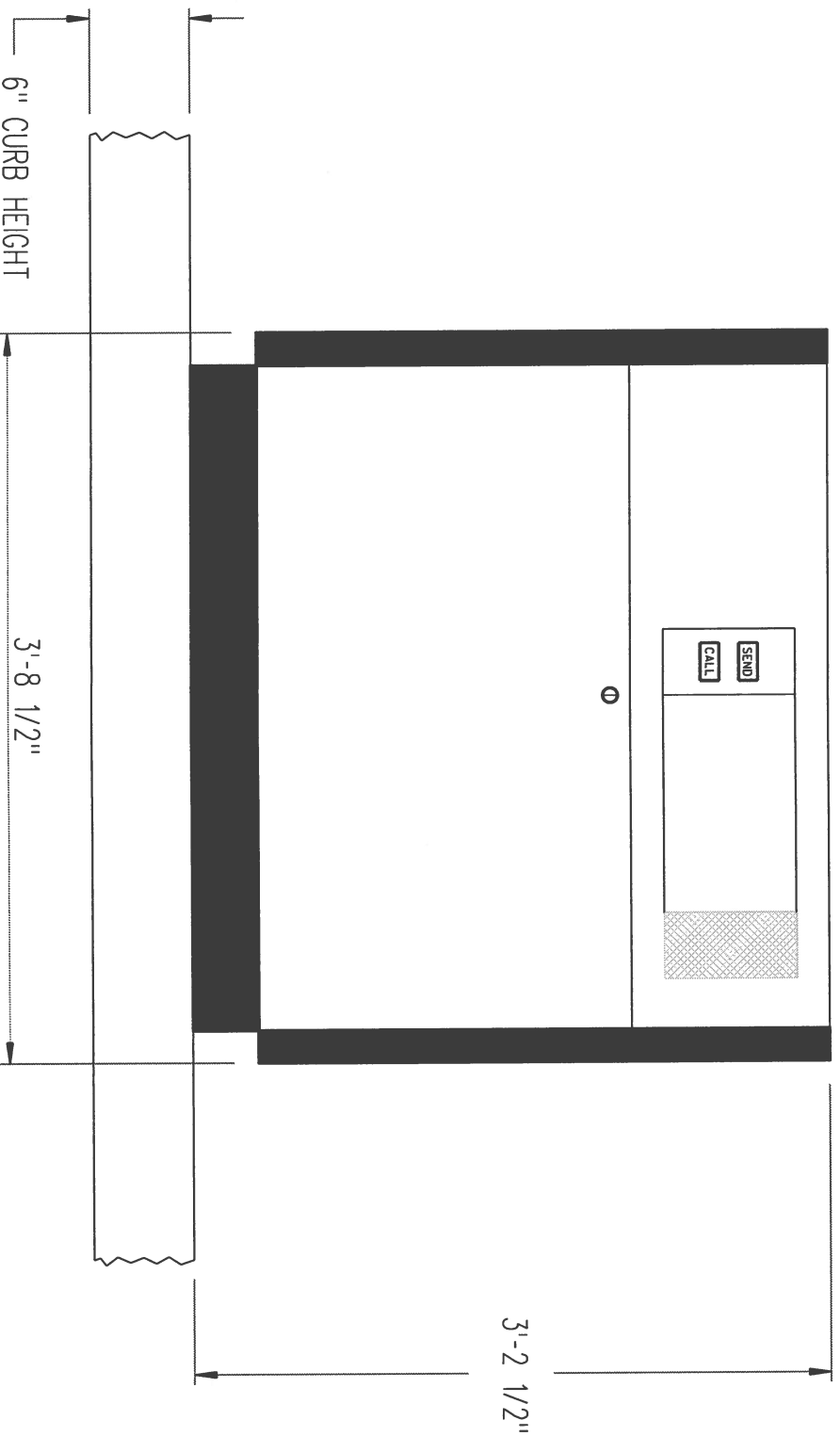
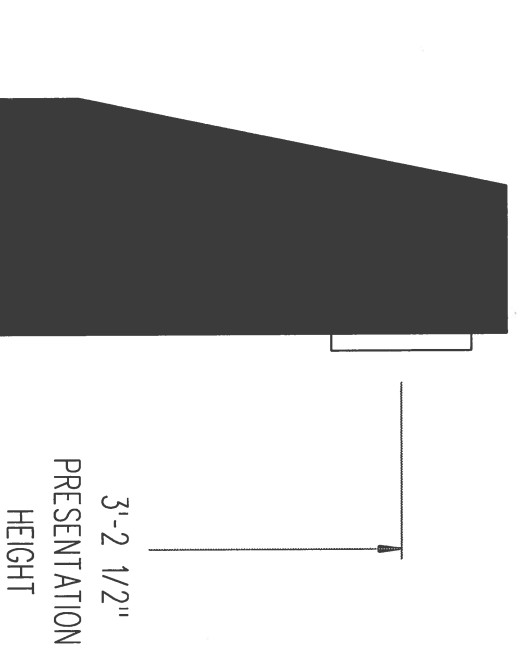
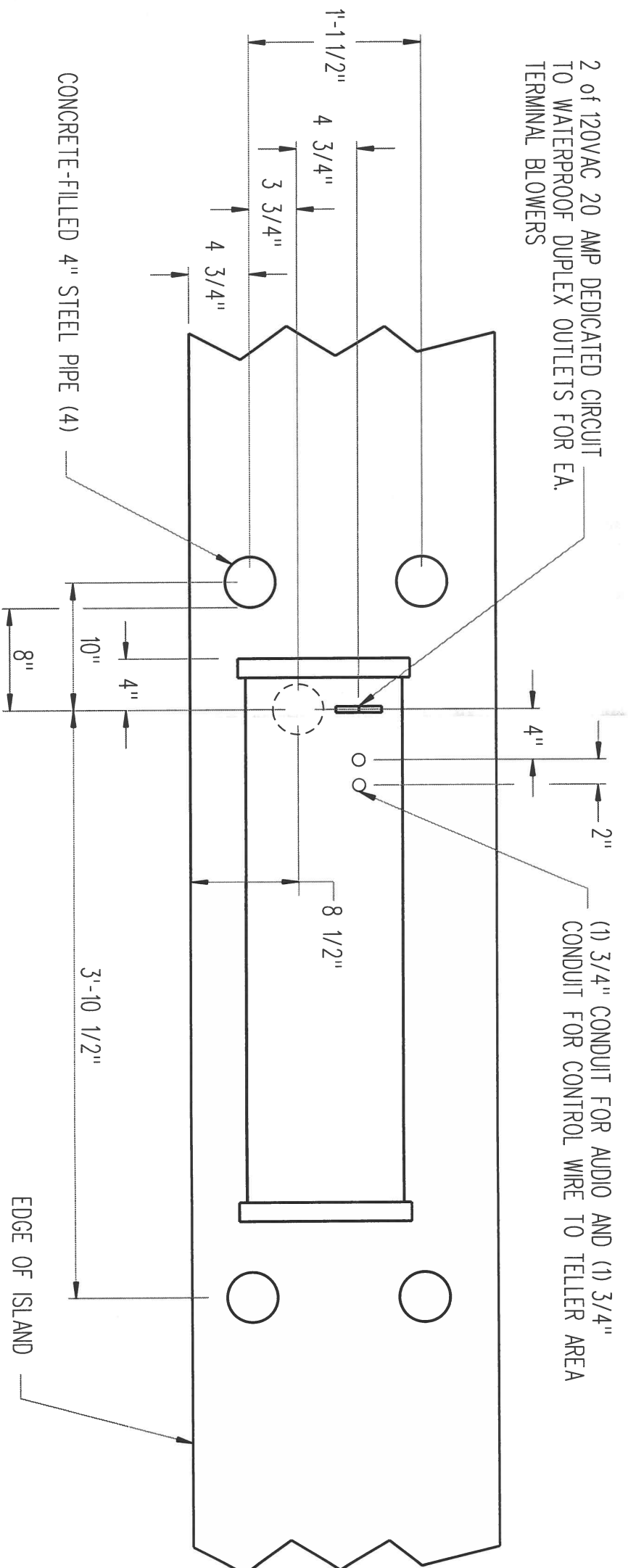

CITY OF MISSION

# 660/880 PNEUMATIC TUBE SYSTEMS STANDARD CUSTOMER UNIT (4.0/4.5)

Project Name:

CITY OF MISSION  
WATER BILL DEPT.  
TELLER UNITS

Date: 3-24-17

Project No: OOS-17

Sheet Number:

M-1

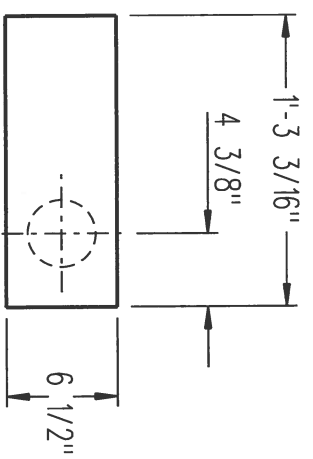

PLAN VIEW

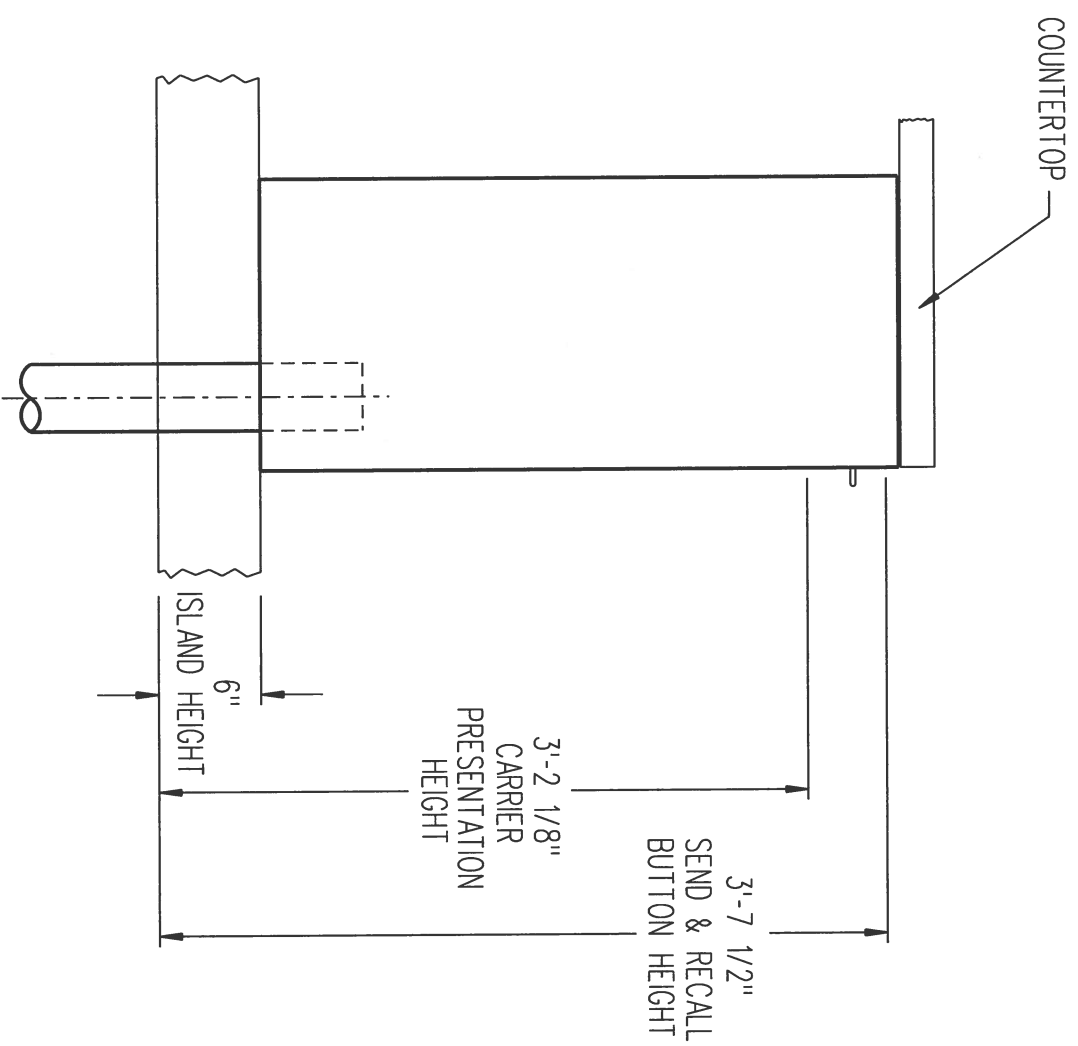

SIDE VIEW

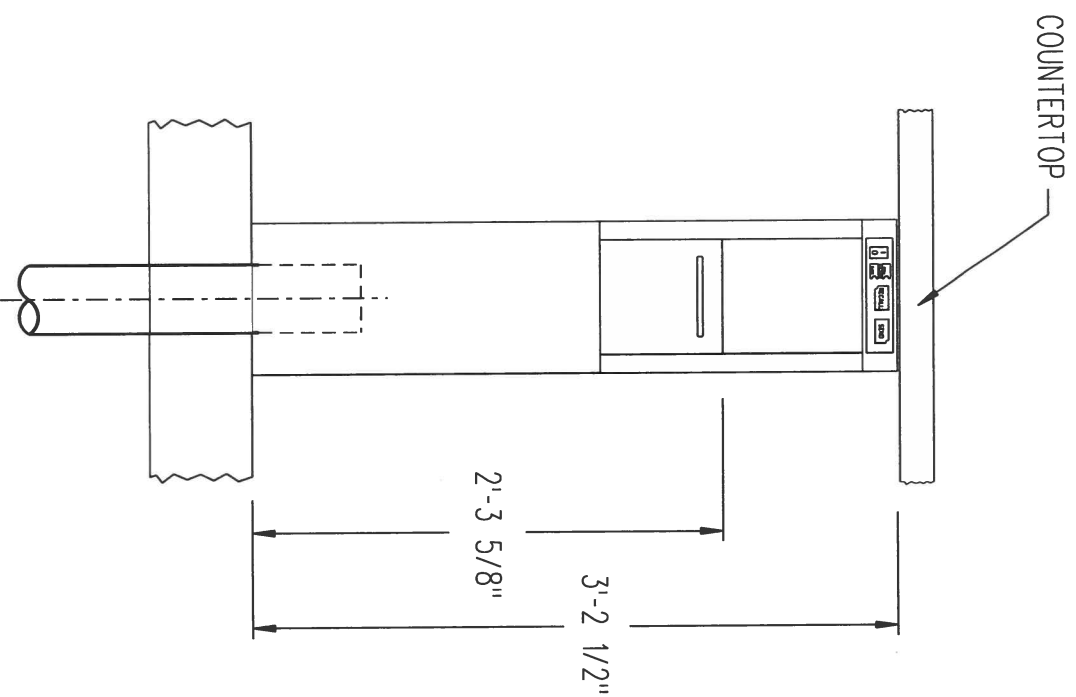

FRONT VIEW

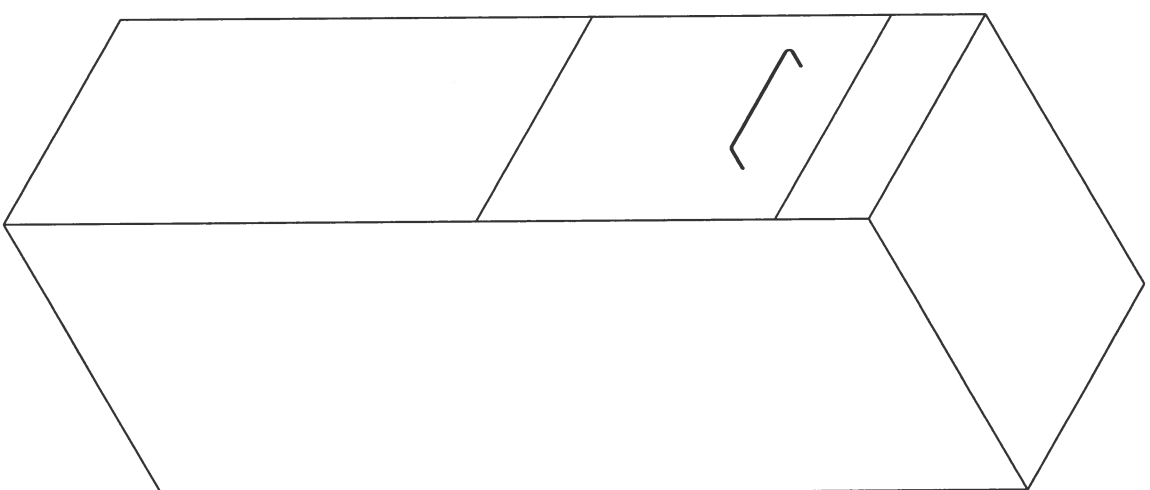

ISO VIEW



CITY OF MISSION

# 23 PNEUMATIC TUBE SYSTEMS TYPE 3 TELLER UNIT DETAILS

Project Name:

CITY OF MISSION  
WATER BILL DEPT.  
TELLER UNITS

Date: 3-24-17

Project No: OOS-17

Sheet Number:

M-1

\* MAXIMUM OPEN SPACE FOR CONDUIT PLACEMENT

(1) 1" CONDUIT FOR AUDIO AND (1) 1" CONDUIT FOR CONTROL WIRE REQUIRED  
 (2) 120VAC 20AMP DEDICATED CIRCUITS TO WATERPROOF DUPLEX OUTLET REQUIRED

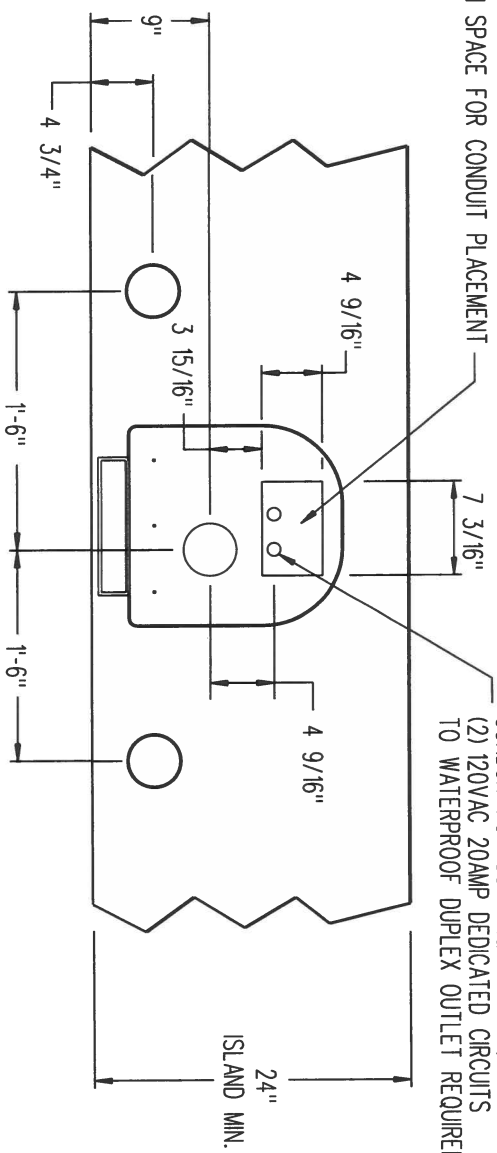

**PLAN VIEW**

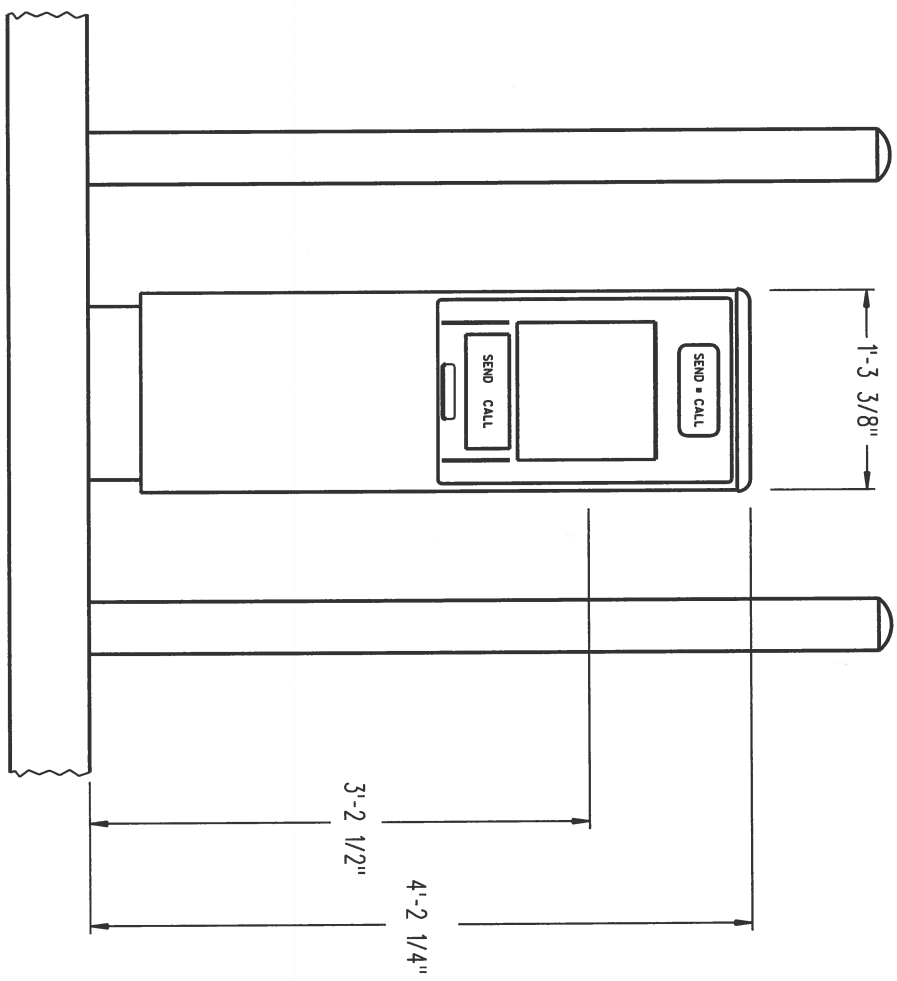

**SIDE VIEW**

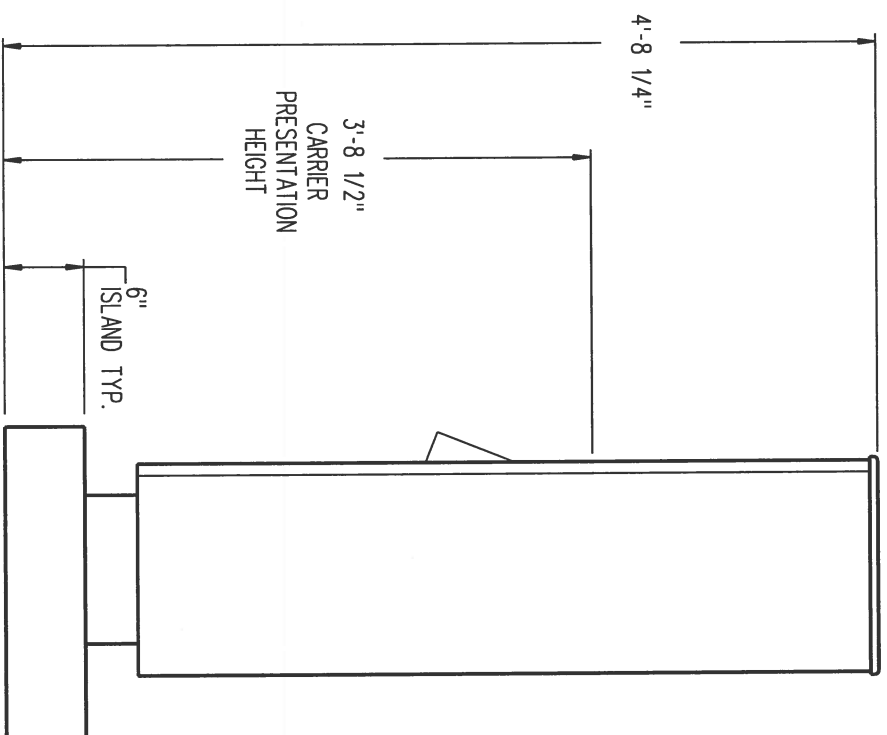

**FRONT VIEW**

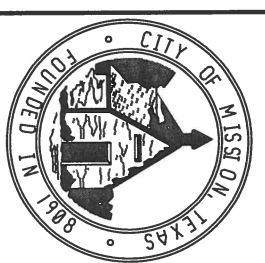

CITY OF MISSION

# MODEL 523 CU REMOTE CUSTOMER UNIT DETAILS

Project Name:

CITY OF MISSION  
 WATER BILL DEPT.  
 TELLER UNITS

Date: 3-24-17

Project No: OOS-17

Sheet Number:

M-2